

## OEM Actuator 5: Proportional

The OEM Actuator 5: Proportional is a thermoelectric actuator for the discrete control of heating and cooling systems. The control of the actuators is performed by a 0-10 V DC signal via a central DDC system or by a room thermostat. Principal area of application is the building management systems range.

Furthermore, the variants with valve stroke recognition automatically register the stroke for an optimum use of the active control voltage range. This guarantees an even more precise control of all valves.

The OEM Actuator of the 5th generation has been specially developed for the customer-specific use in OEM businesses. The modular structure offers diverse differentiation possibilities for customer-specific designs.



### 1.1 Features

- Modern OEM design
- Travel path variants 4.0 mm / 5.0 mm (further variants on request)
- Designs “normally closed” (NC) and “normally open” (NO)
- Power consumption of only 1 watt
- Control by a 0-10 V DC signal
- Optionally with valve stroke recognition
- Short response times, resulting in improved control response
- Closing point verification and possible adaptation during operation
- Complete compatibility to the valve adapter system
- Simple plug-in installation
- 360° installation position
- Patented 100% protection in case of leaky valves
- “First open” function
- Adaptation check on the valve
- Plug-in connecting cable
- Alignment aid on the valve
- Compact size, small dimensions
- All around function display
- Noiseless and maintenance-free
- High functional safety and long expected service life
- Optionally also as 24 V DC variant
- Certified by the TÜV

### 1.2 Variants

In its basic version, the OEM Actuator 5: Proportional is delivered in a neutral design without logo with plugged connection cable, function display white/white, without valve adapter and laser marking. The following variants are available in the basic version.

Types	Stroke recognition	Operating voltage		Control voltage	Stroke	Closing force	Control direction	Average actuation delay	Scope of supply
APR 40405-00N	no	24 V	AC	0 – 10 V	4.0 mm	100 N	NC	30 s/mm	<ul style="list-style-type: none"> <li>• OEM Actuator 5: Proportional in individual packing</li> <li>• 1 m connection line (plug-in), white PVC 3 x 0.22 mm<sup>2</sup></li> <li>• Installation instruction in 12 languages</li> </ul>
APR 40405-01N	no	24 V	AC	2 – 10 V	4.0 mm	100 N	NC	30 s/mm	
APR 40405-02N	no	24 V	AC	10 – 0 V	4.0 mm	100 N	NC	30 s/mm	
APR 42405-00N	no	24 V	DC	0 – 10 V	4.0 mm	100 N	NC	30 s/mm	
APV 41405-10N	yes	24 V	AC	0 – 10 V	4.0 mm	100 N	NO	30 s/mm	
APV 43405-10N	yes	24 V	DC	0 – 10 V	4.0 mm	100 N	NO	30 s/mm	
APR 40505-00N	no	24 V	AC	0 – 10 V	5.0 mm	100 N	NC	30 s/mm	
APR 40505-01N	no	24 V	AC	2 – 10 V	5.0 mm	100 N	NC	30 s/mm	
APR 40505-02N	no	24 V	AC	10 – 0 V	5.0 mm	100 N	NC	30 s/mm	
APR 42505-00N	no	24 V	DC	0 – 10 V	5.0 mm	100 N	NC	30 s/mm	
APV 40505-00N	yes	24 V	AC	0 – 10 V	5.0 mm	100 N	NC	30 s/mm	
APV 40505-01N	yes	24 V	AC	2 – 10 V	5.0 mm	100 N	NC	30 s/mm	
APV 40505-02N	yes	24 V	AC	10 – 0 V	5.0 mm	100 N	NC	30 s/mm	
APV 42505-00N	yes	24 V	DC	0 – 10 V	5.0 mm	100 N	NC	30 s/mm	

**The following extension possibilities resp. differentiations from the basic version are available optionally:**

Line lengths	Standard	2 m, 3 m, 5 m, 10 m, 15 m; PVC in white – 3 x 0.22 mm <sup>2</sup> (special lengths up to 20 m)
	Non-halogen line	1 m, 2 m, 3 m, 5 m, Hal F LiYY 3 x 0.22 mm <sup>2</sup> / white For the compliance with fire protection and environmental regulations.
Valve adapters	Available for almost all valves and distributors	
Packaging	Packaging can be manufactured and printed individually according to requirements.	
Imprint on casing	Laser marking of the company logo and the individual type designation	
Colour of casing and cable	Homogeneous colouring, colour of the function display or function cap matching your product design or corporate design	
Please contact us if you have further wishes.		

**Accessories**

- Protection cap SK 1004

## 2 Function

The actuator mechanism of the OEM Actuator uses a PTC resistor-heated elastic element and a compression spring. The elastic element is heated by applying the operating voltage and moves the integrated plunger. The force generated by this movement is transferred to the plunger, thus opening or closing the valve.

### 2.1 Version NC: Normally-closed with and without valve stroke recognition (valve closed)

In factory setting, NC and NO actuators keep the valve opened. For the NC actuator, this is achieved with the "First-Open" function. The first-open function is unlocked initially for the NC actuator after switching on the operating voltage for the first time. Subsequently both actuator types (NC and NO) automatically determine the valve closing point. For actuators with valve stroke recognition, the stroke is detected additionally. After this process the actuators assume their normal operation. The saved values are used for control requirements and for position determination after a voltage interruption. The saved values are checked during the running operation and adapted as needed in order to counteract deviations. This process guarantees an optimum adaptation of the actuator to the valve. If a control voltage is applied after the closing point detection, the actuator opens the valve evenly with the plunger movement after the dead time has elapsed, and the actuator moves precisely to the calculated position.

An internal wear-free position detection controls the temperature required for the maximum stroke (minus over-elevation) and consequently the energy intake of the elastic element. No excess energy is stored inside the elastic element. If the control voltage is reduced, the electronic control system immediately adapts the heat input to the elastic element. In the range of 0 – 0.5 V (depending on the model) the actuator remains in a quiescent state in order to ignore ripple voltage occurring in long cables ( $r_{pm}$ ). The closing force of the compression spring is matched to the closing force of commercially available valves and keeps the valve closed when de-energised.

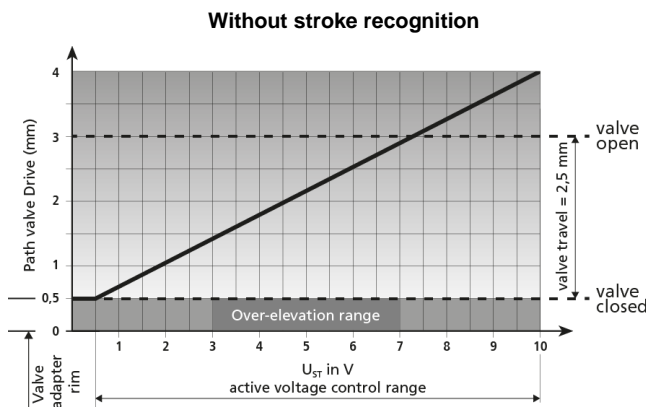

If a 4 mm actuator without valve stroke recognition is used for valves with a stroke of 2,5 mm, the actuator drives without load for control voltages from 7.5 V to 10 V.

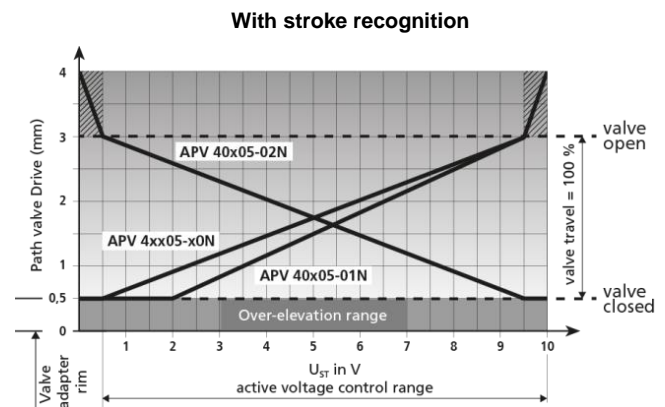

For the variant with valve stroke recognition, the actuator calculates the stroke and automatically adapts the active control voltage range to this. This allows an even more precise control of the valve. The complete voltage spike of the thermostat is used for flow control purposes.

### 2.2 Function display

The function display (all around display) of the OEM Actuator shows at the first glance whether the valve is open or closed; this can also be felt in the dark.

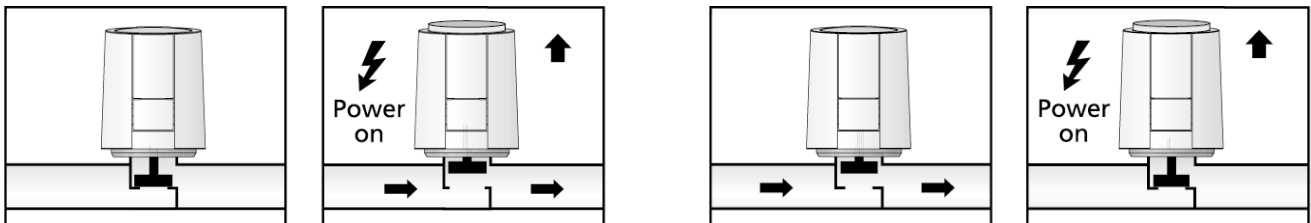

For the **version NC: Normally closed** extracts the function display when the valve opens.

For the **version NO: Normally open** extracts the function display when the valve is closed.

### 2.3 "First Open" function (for NC variants only)

In its delivery condition, the OEM Actuator is normally open due to the "First Open" function. This enables heating operation during the carcass construction phase even when the electric wiring of the room-by-room temperature control is not yet complete. When commissioning the system at a later date, the "First Open" function is automatically unlocked by applying the operating voltage (for more than 6 minutes) and the actuator is fully operable.

### 3 Technical data

Voltage (according to variant)	24 V AC, -10 % ... +20 %, 50-60 Hz 24 V DC, -20 % ... +20 %,	
Control voltage range	0 V... 10 V (reverse polarity protected)	
Max. inrush current	< 320 mA for max. 2 min.	
Operating power	1 W <sup>1)</sup>	
Resistance of control voltage input	100 kΩ	
Stroke	4.0 / 5.0 mm (minus 0.5 mm over-elevation)	
Actuation force	100 N +5 %	
Fluid temperature	0 °C to +100 °C <sup>2)</sup>	
Storage temperature	-25 °C to +60 °C	
Ambient temperature	0 °C to +60 °C	
Degree of protection	IP 54 <sup>3)</sup>	
Protection Class	III	
CE conformity according to	EN 60730	
Casing	material	Polyamide
	colour	white
Connection line	type	3 x 0.22 mm <sup>2</sup> PVC
	colour	white
	length	1 m
Weight with connection cable (1 m)	111 g	
Overvoltage strength according to EN 60730-1	1 kV	

1) measured with precision power meter LMG95  
2) or higher, depending on the adapter  
3) in all installation positions

#### 3.1 Dimensions

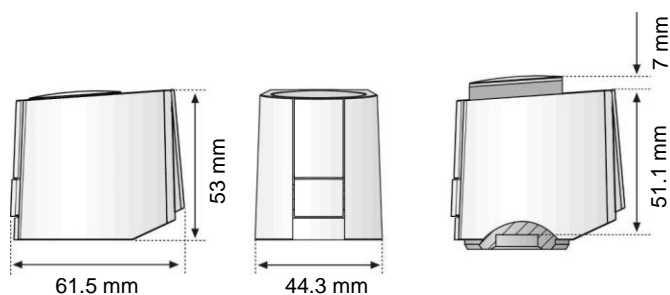

Dimensions

Installation height

#### 3.2 Certificates



The OEM Actuator 5 is certified by TÜV Süd.

## 4 Installation notes

### 4.1 Installation with valve adapter

The valve adapter assortment guarantees a perfect match of the actuator to almost all valve bottoms and heating circuit distributors available on the market. The OEM Actuator 5 is simply plugged on to the valve adapter previously installed manually.

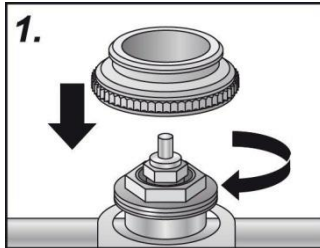

1. Screw the valve adapter manually onto the valve.

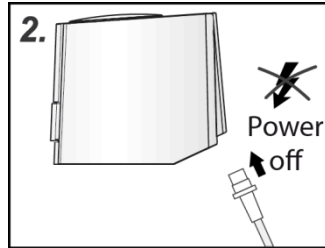

2. Connect the line to the actuator.

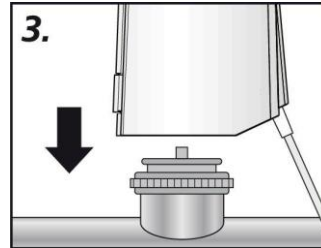

3. Position the OEM Actuator manually in vertical position to the valve adapter.

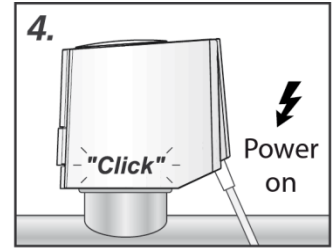

4. Latch the OEM Actuator 5 to the valve adapter by manually applied vertical pressure until a clicking sound is heard.

### 4.2 Installation position

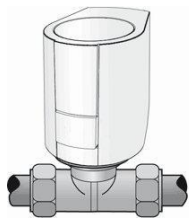

vertical

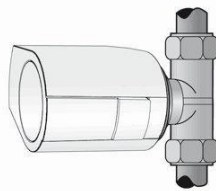

horizontal

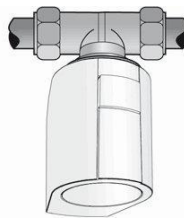

“overhead”

The OEM Actuator must be installed preferably in vertical or horizontal installation position. In case of “overhead” installation, special circumstances (e. g. drain water) can reduce the lifetime of the actuator.

### 4.3 Electric connection

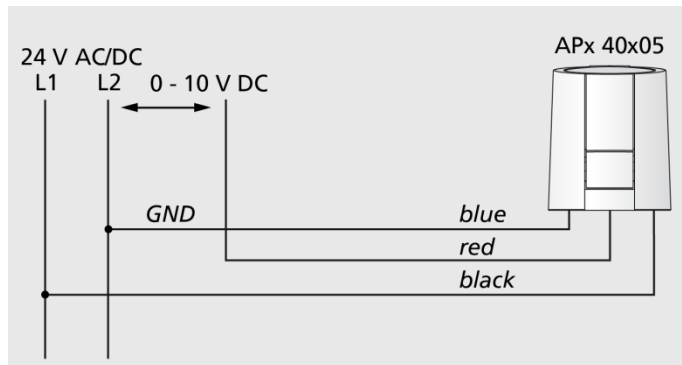

#### Cable

We recommend the following cable lengths for installing a 24 V system:

Cable	Section	Length
Standard DDC line	0.22 mm <sup>2</sup>	20 m
J-Y(ST)Y	0.8 mm	45 m
NYM / NYIF	1.5 mm <sup>2</sup>	136 m

#### Transformer/power supply

A safety isolating transformer according to EN 61558-2-6 (for the AC variant) or a switching power supply according to EN 61558-2-16 (for DC variant) must always be used.

The dimensioning of the transformer or the switching power supply results from the making capacity of the OEM Actuators.

Rule-of-thumb formula:  $P_{\text{transformer}} = 6 \text{ W} \times n$   
 n = Number of OEM Actuators

Technical changes reserved. Reprint, including partial reprint, only with consent of Möhlenhoff GmbH.